



WWW.DEADONTOOLS.COM



Tools and parts shown are not included
Product specifications herein could change without notice

Dead On® Tools
Pull'R Holding Company, LLC
415 E State Parkway, Schaumburg, IL 60173
deadontools.com // deadonstore.com

© 2018 Pull'R Holding Company, LLC

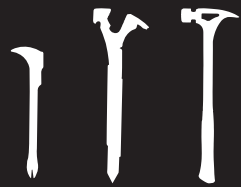

W O R K G E A R & T O O L S

A COLLISION OF SERIOUS TOOL USING **PROFESSIONALS** AND A LIFESTYLE LIVED OUT



LOUD

CONTENTS

03 HAMMERS

12 RIGS & POUCHES

07 ANNIHILATORS

17 STORAGE & ACCESSORIES

09 EXHUMERS

19 KNEE PADS

⚠ WARNING: Certain products identified with this symbol ▼ can expose you to di(2-ethylhexyl)phthalate (DEHP), which is known to the State of California to cause cancer and birth defects or other reproductive harm. For more information go to www.P65Warnings.ca.gov.

SKU #	ITEM DESCRIPTION	PAGE #
Hammers		
DOS22M-HD	Steel Hammer (<i>Milled Face, 22oz.</i>)	3-4
DOS22S-HD	Steel Hammer (<i>Smooth Face, 22oz.</i>)	3-4
DO21	Investment Cast Wood Hammer (<i>18" Straight Hickory Handle, 21oz.</i>)	5
DO21C	Investment Cast Wood Hammer (<i>16" Curved Hickory Handle, 21oz.</i>)	5
DO16-GS	Graphite Hammer (<i>Smooth Face 16 oz.</i>)	6
DO20-GS	Graphite Hammer (<i>Smooth Face 20 oz.</i>)	6
Annihilators		
AN14	Annihilator 14 (<i>14" Wrecking/Utility Bar</i>)	7-8
AN18	Annihilator 18 (<i>18" Wrecking/Utility Bar</i>)	7-8
Exhumers		
EX8	Exhumer 8 Nail Puller (<i>8-5/8"</i>)	9-10
EX9	Exhumer 9 Nail Puller (<i>10-5/8"</i>)	9-10
EX9CL	Exhumer Classic Nail Puller (<i>10-1/2"</i>)	9-10
Rigs & Pouches		
DO-BSR	<i>Cordura® Ballistic Nylon</i> Framer's Suspension Rig	13
HDP369857	<i>1680 Denier Poly</i> Framer's Suspension Rig	13
HDP400945	<i>1680 Denier Poly</i> Carpenter's Suspension Rig	14
HDP411014	<i>1680 Denier Poly</i> Electrician's Suspension Rig	14
DO-FR	<i>600 Denier Poly</i> Tool Rig with Suspenders	15
HDP222496	<i>1680 Denier Poly</i> Electrician's Pouch	15
HD54017	<i>600 Denier Poly</i> Utility Pouch	16
DO-TH	<i>600 Denier Poly</i> Killer Precision™ Tape Measure Holder	16
DO-400S	<i>600 Denier Poly</i> Cell Punk™ Cell Phone Holder - Small	16

SKU #	ITEM DESCRIPTION	PAGE #
Storage & Accessories		
DOH-B2	Black Skull Logo Hat	16
DSTSKULLY-S	Dead On Job-Construction (SM)	16
DSTSKULLY-M	Dead On Job-Construction (MD)	16
DSTSKULLY-L	Dead On Job-Construction (LG)	16
DSTSKULLY-XL	Dead On Job-Construction (XL)	16
DSTSKULLY-XXL	Dead On Job-Construction (XXL)	16
DO-DES	The Destroyer Tech Pack	17-18
Kneepads		
HDP223186	No Rock Gel Kneepads	20
HD98000	Gel Hard Cap Kneepads	21
HDP223155	Gel Flexible Kneepads	21
HD99000	Gel Eliminator Kneepads	22
HD95000	Gel All Terrain Kneepads	22

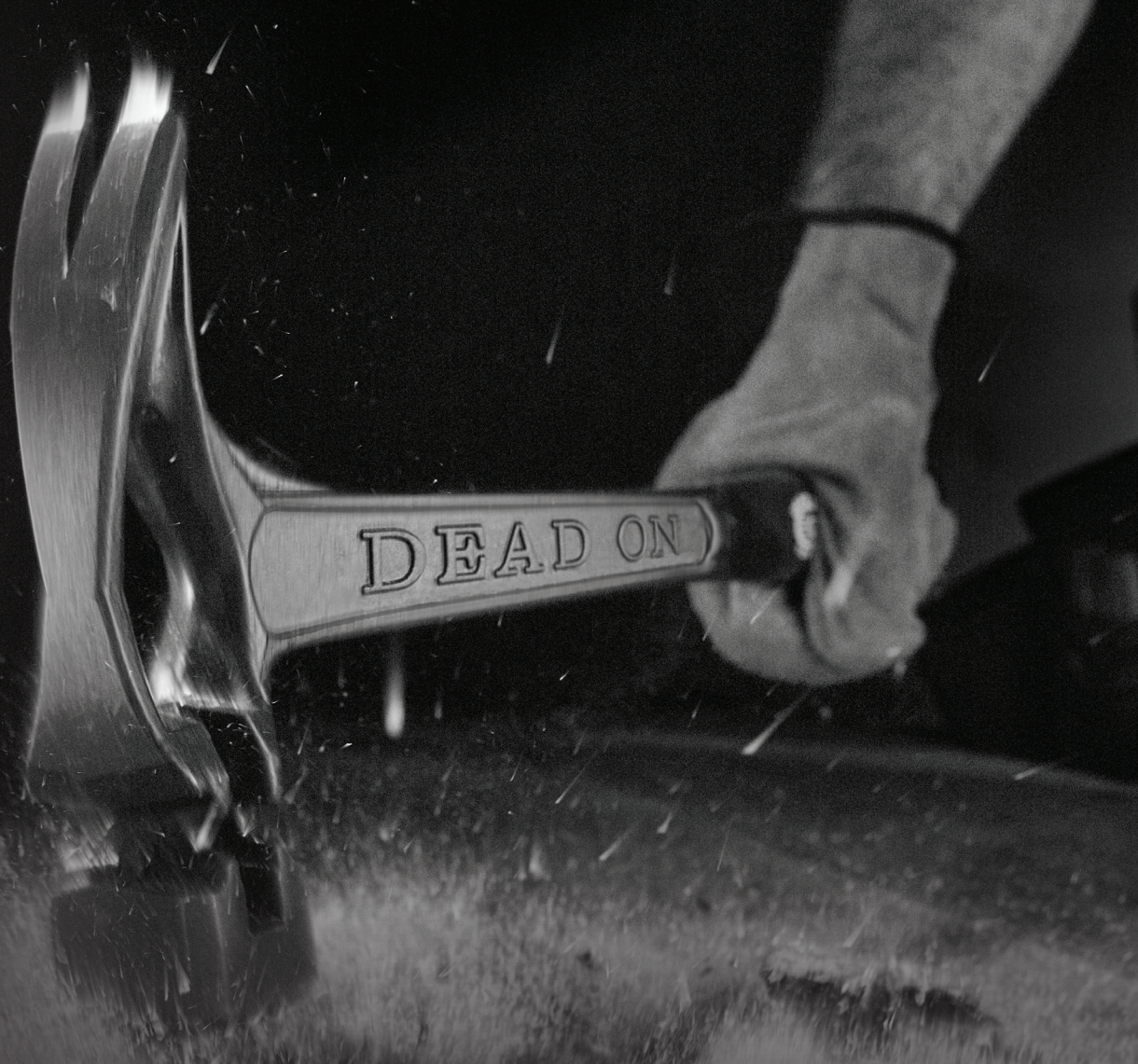

HAMMERS

MAXIMUM PERFORMANCE WITH NO LIMITS

Dead On® Tools sets the highest standard for precision in tools and work gear products. We offer legendary performance through increasingly innovative tools. Tools that represent quality that others pursue because they began with actual users in the trade.

STEEL



*INVESTMENT CAST
WOOD*



GRAPHITE



STEEL

HAMMERS



▼ DOS22M-HD

▼ DOS22S-HD

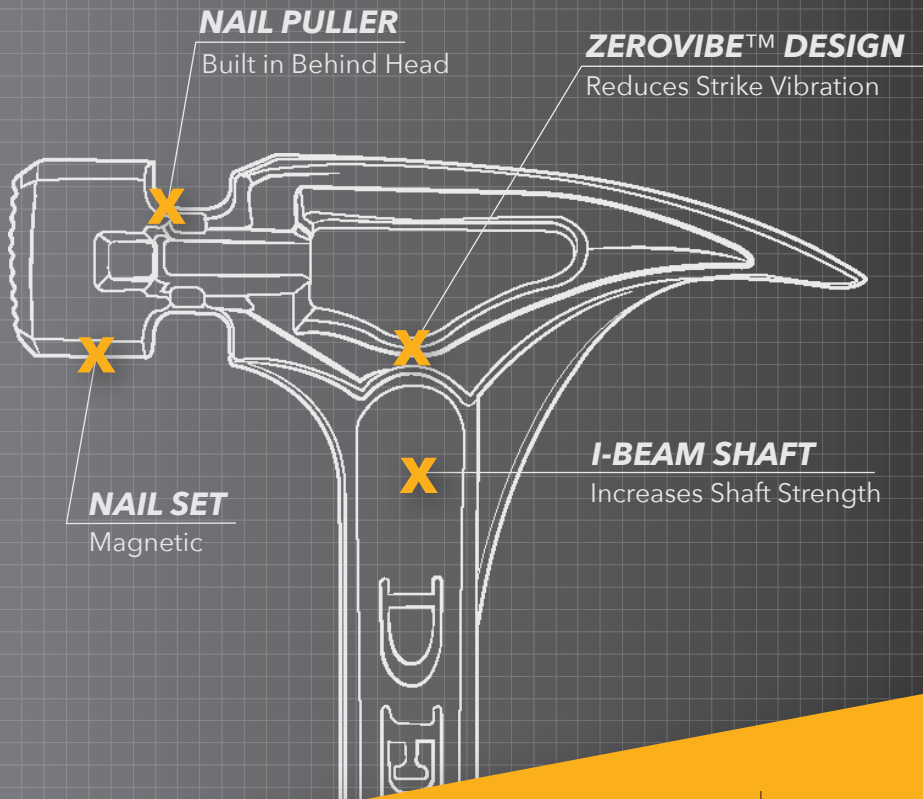
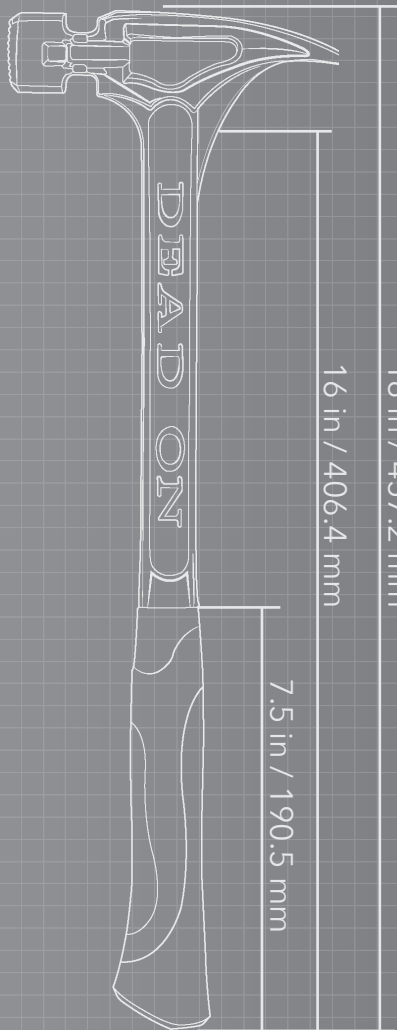

SPECIFICATIONS

	DOS22M-HD	DOS22S-HD
FACE	Milled	Smooth
HEAD WEIGHT	22 oz.	22 oz.
OVERALL WEIGHT	2.2 lbs.	2.2 lbs.
OVERALL LENGTH	18 in.	18 in.

INVESTMENT
CAST

WOOD HAMMERS



▼ DO21

▼ DO21C



What is
**Investment
Casting?**

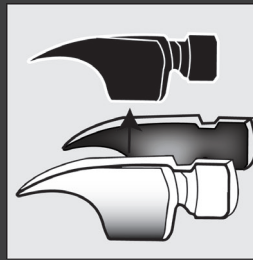
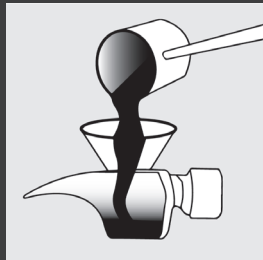

This process allows each head to be identical and remarkably balanced. S-7 steel is shock resistant and made for high impact work that would disfigure lesser hammers.

NAIL SET
Magnetic

S-7 INVESTMENT CAST HEAD

For a Perfect Strike, Every Time

HICKORY HANDLE

SPECIFICATIONS

	DO21	DO21C
FACE	Milled	Milled
HEAD WEIGHT	21 oz.	21 oz.
HANDLE	Straight	Curved
OVERALL LENGTH	18 in.	18 in.

GRAPHITE

HAMMERS



▼ DO16-GS

▼ DO20-GS

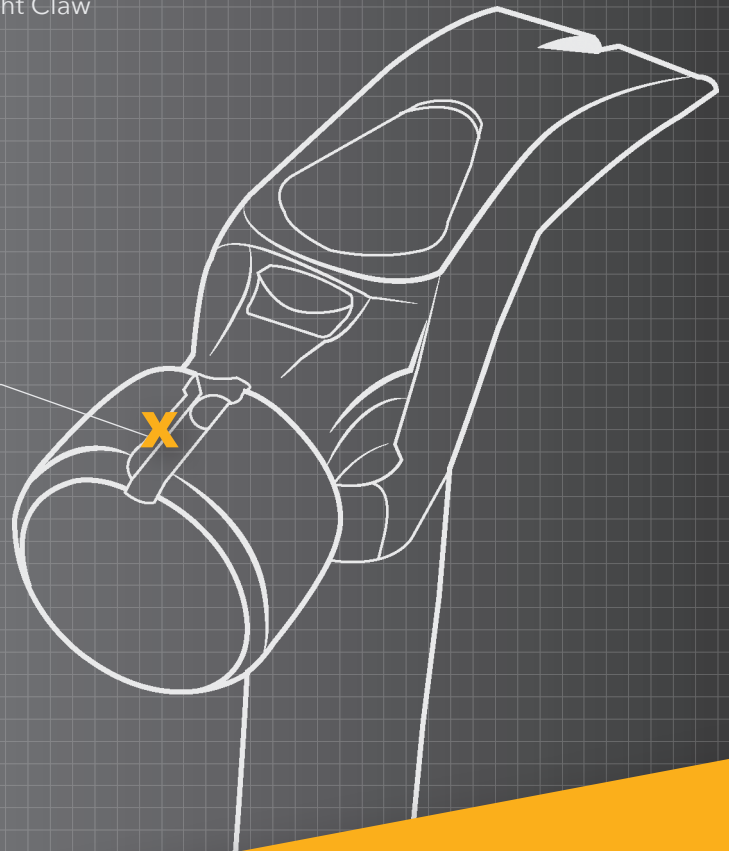
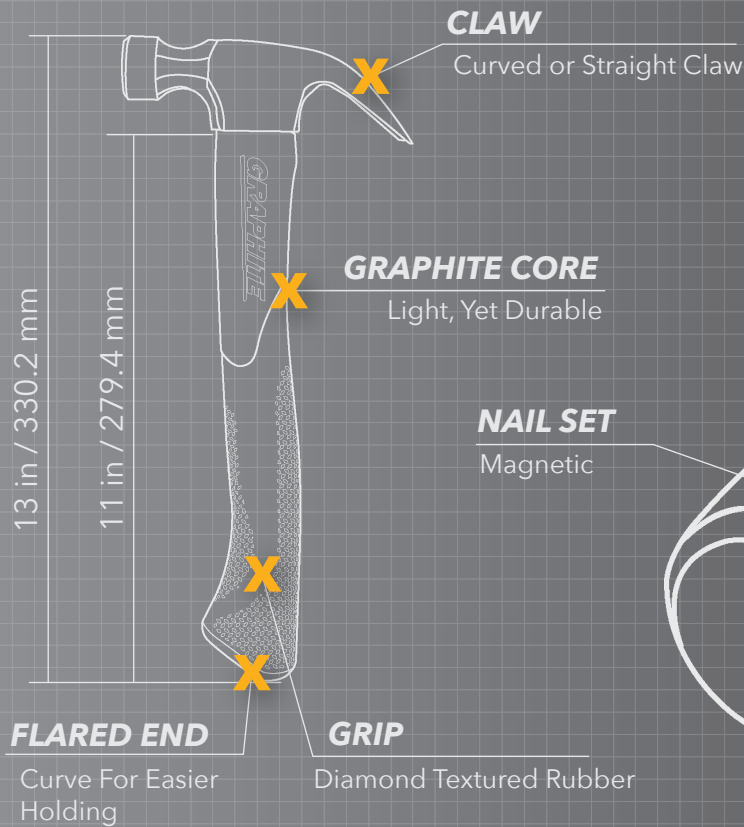

SPECIFICATIONS

	DO16-GS	DO20-GS
FACE	Smooth	Smooth
HEAD WEIGHT	16 oz.	20 oz.
CLAW	Curved	Straight
OVERALL LENGTH	13 in.	13 in.

ANNIHILATORS

THE ULTIMATE WRECKINGBAR

▼ AN18



▼ AN14

A wrecking bar and hammer hybrid, the Annihilator is our answer to the toughest jobs out there. Boasting a demolition hammer, axe, wrench, chisel and even a bottle opener, this tool does it all.

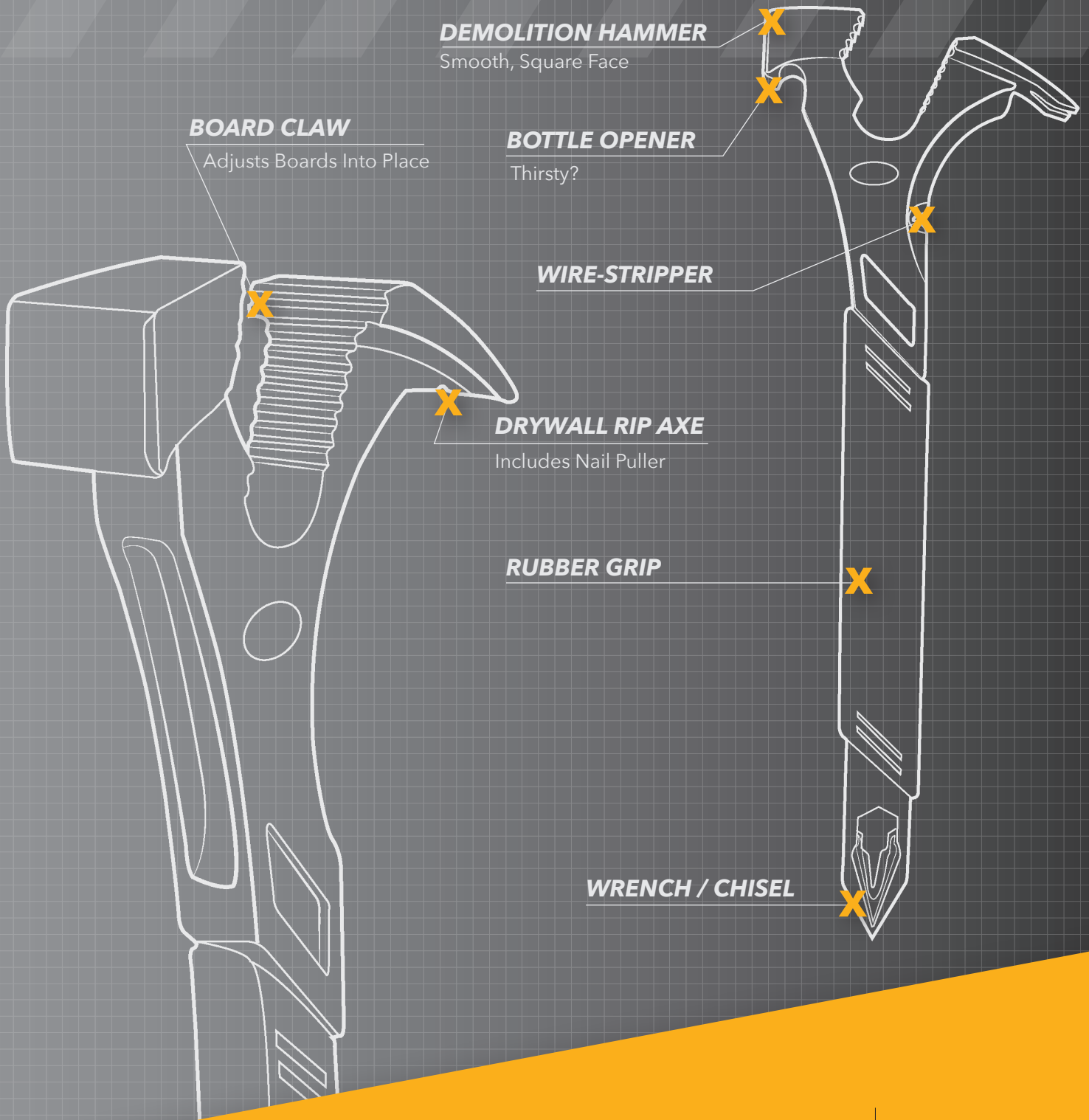

SPECIFICATIONS

	AN14	AN18
FACE	Smooth	Smooth
OVERALL WEIGHT	2.0 lbs.	3.7 lbs.
BAR LENGTH	9 in.	12 in.
OVERALL LENGTH	14 in.	18 in.

EXHUMERS

THE BEST NAILPULLERS



Our latest models of Dead On® Exhumers offer an array of unique features that enhance user experience. They are equipped with the latest technological advances offering dual nail picks, nail extractor, built-in saw blade wrench and even a bottle opener after a satisfying day on the job.

SAW BLADE WRENCH

EX8 / EX9

BOTTLE OPENER

Because We Can

NAIL PICK

Featured On All 3 Models

NAIL EXTRACTOR

Easily Removes Embedded Nails

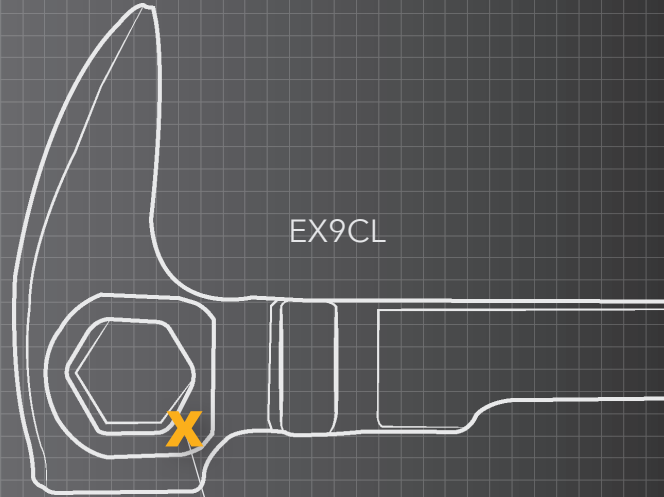
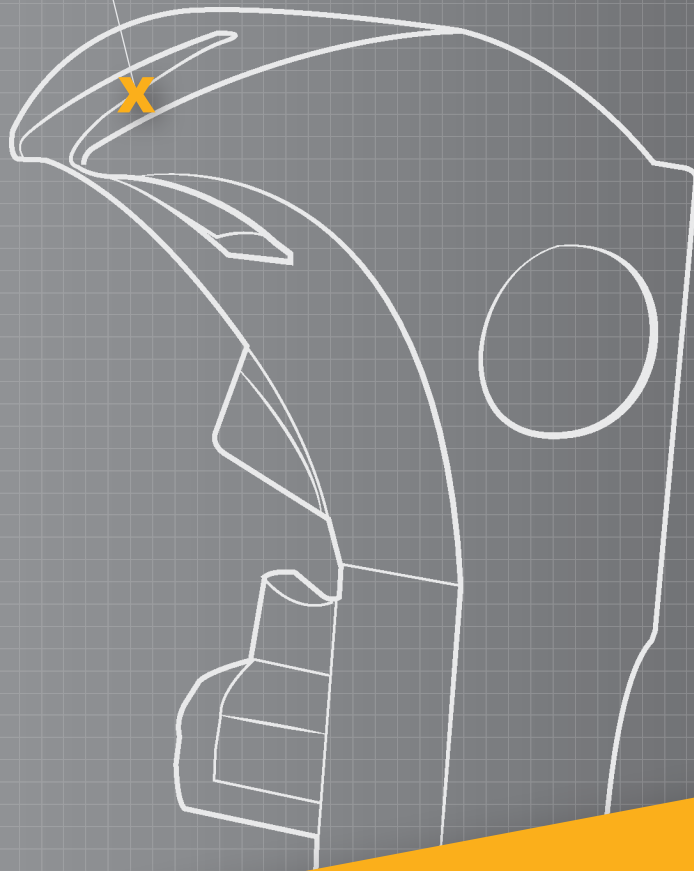

EX9CL

SAW BLADE WRENCH

SPECIFICATIONS

	EX8	EX9	EX9CL
OVERALL WEIGHT	0.9 lbs.	1.2 lbs.	0.8 lbs.
BAR LENGTH	8.6 in.	10.6 in.	10.5 in.

WORKGEAR

BUILT TOUGH, BUILT TO LAST

Dead On® has taken the same care used in designing its innovative tools and applied it to work gear. The design of our rigs and pouches come from endless testing with our end-users; the right tools in the right place.

RIGS & POUCHES



STORAGE



KNEE PADS



1 **EXPERIENCED** PROFESSIONAL

Ballistic Nylon



Tear Strength:
10.3 X

Puncture Resistance:
4.1 X

Abrasion Resistance:
2.5 X



Ballistic Nylon
FRAMER'S
SUSPENSION RIG

▼ DO-BSR



2 **PROFESSIONAL**

1680 Denier Poly



Tear Strength:
2.5 X

Puncture Resistance:
2.0 X

Abrasion Resistance:
1.6 X



1680 Denier Poly
FRAMER'S
SUSPENSION RIG

▼ HDP369857



1680 Denier Poly
CARPENTER'S
SUSPENSION RIG

▼ HDP400945



1680 Denier Poly
ELECTRICIAN'S
SUSPENSION RIG

▼ HDP411014



3 **JOURNEYMAN**

600 Denier Poly

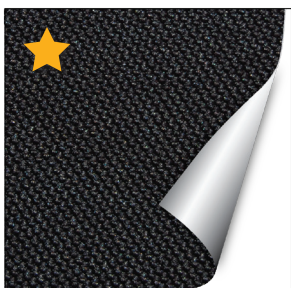

Strength & Resistance measured against 600 Denier Poly at 1x



600 Denier Poly
TOOL RIG
WITH SUSPENDERS

▼ DO-FR





Ballistic Nylon

FRAMER'S

SUSPENSION RIG ▼ DO-BSR

- » Ballistic Nylon Material
- » LoadBear™ Stretch Suspension
- » Infinity Belt Fits Up to a 52" Waist
- » Barrel Bottom Pouches For Extra Capacity
- » Single Body Pouch Construction
- » Monster Grommets On Belt
- » Speed Square Pocket
- » Dual Hammer Loop – Steel & Web
- » Cell Phone Pocket Holds Most Smart Phones
- » Tape Measure Top Pocket
- » Chest Retaining Strap
- » Moisture Wicking Belt and Shoulder Lining

Pockets: 17 Long Tool Loops: 2



BALLISTIC NYLON
★★★

FRAMER

3 BAG



1680 Denier Poly

FRAMER'S

SUSPENSION RIG ▼ HDP369857

- » 1680 Denier Poly Material
- » LoadBear™ Stretch Suspension
- » Infinity Belt Fits Up to a 52" Waist
- » Barrel Bottom Pouches For Extra Capacity
- » Single Body Pouch Construction
- » Monster Grommets On Belt
- » Speed Square Pocket
- » Dual Hammer Loop – Steel & Web
- » Cell Phone Pocket Holds Most Smart Phones
- » Tape Measure Top Pocket
- » Chest Retaining Strap
- » Moisture Wicking Belt and Shoulder Lining

Pockets: 17 Long Tool Loops: 2



1680 DENIER POLY
★★

FRAMER

3 BAG



1680 Denier Poly

CARPENTER'S SUSPENSION RIG

▼ HDP400945

1680
DENIER POLY
★★

CARPENTER

2
BAG



- » 1680 Denier Poly Material
- » LoadBear™ Stretch Suspension
- » Infinity Belt Fits Up to a 52" Waist
- » Barrel Bottom Pouches For Extra Capacity
- » Single Body Pouch Construction
- » Monster Grommets On Belt
- » Speed Square Pocket
- » Dual Hammer Loops – Steel & Web
- » Cell Phone Pocket Holds Most Smart Phones
- » Tape Measure Top Pocket
- » Chest Retaining Strap
- » Moisture Wicking Belt and Shoulder Lining

Pockets: 16 Long Tool Loops: 2



1680 Denier Poly

ELECTRICIAN'S SUSPENSION RIG

▼ HDP411014

1680
DENIER POLY
★★

ELECTRICIAN

2
BAG



- » 1680 Denier Poly Material
- » LoadBear™ Stretch Suspension
- » Infinity Belt Fits Up 52" Waist
- » Barrel Bottom Pouches For Extra Capacity
- » Single Body Pouch Construction
- » Monster Grommets On Belt
- » Web Hammer Loop
- » Cell Phone Pocket Holds Most Smart Phones
- » Tape Measure Clip
- » Moisture Wicking Belt and Shoulder Lining
- » Adjustable Drill Holster
- » Tall Front Pockets for Holding Meters

Pockets: 13 Long Tool Loops: 23



600 Denier Poly

TOOL RIG

WITH SUSPENDERS ▼ DO-FR

- » 600 Denier Poly Material
- » Barrel Bottom Pouches For Extra Capacity
- » Belt Fits Up to a 46" Waist
- » Dual Hammer Loops – Steel & Web
- » Double Grommets On Belt
- » Speed Square Pocket

Pockets: 24



600
DENIER POLY
★

CARPENTER

2
BAG



1680 Denier Poly

ELECTRICIAN'S

POUCH ▼ HDP222496

- » 1680 Denier Poly Material
- » Tall Front Pockets for Holding Meters
- » Tunnel Loop for Belt
- » Web Hammer Loop
- » Removable, Adjustable Shoulder Strap
- » Metal Tape Measure Clip
- » Web Tape Roll Holder
- » Industrial-grade hardware

Pockets: 14 Long Tool Loops: 16



1680
DENIER POLY
★★

ELECTRICIAN

★ 600 Denier Poly
UTILITY POUCH
 ▼ HD54017

- » 600 Denier Poly Material
- » 3 Back-wall Tool Slots
- » T-Chain Toggle Tape Roll Holder
- » Metal Tape Measure Clip
- » Durable Molded Handle
- » Carabiner Included
- » Total Number of Pockets: 12



★ 600 Denier Poly
CELL PUNK™
 CELL PHONE HOLDER
 ▼ DO-400S

- » Stretch Mesh Front Holds Most Smart Phones
- » Shown with iPhone® 5 (left)
- » Dual Fastening System; Clip or Use Belt Loop
- » Compatible with Dead On® Rig System

★ 600 Denier Poly
KILLER PRECISION
 TAPE MEASURE HOLDER ▼ DO-TH

- » Dual Fastening System; Clip or Use Belt Loop
- » Locking Strap with Snap
- » Compatible with Dead On® Rig System



BLACK SKULL LOGO HAT
 ▼ DOH-B2

DEAD ON® T-SHIRT
 "This Job Is Killing Me!"

- DSTSKULLY-S ▼
- DSTSKULLY-M
- DSTSKULLY-L
- DSTSKULLY-XL
- DSTSKULLY-XXL



THE DESTROYER

TECH PACK

BACKPACK / TOOL PACK





THE WORKSTATION, REIMAGINED

- » 1680 Denier Poly Material
- » Overall Size: 20" x 17" x 10"
- » Total Weight: 7.1 lbs.
- » Signature Dead On Skull Molded Front Pocket
- » Durable Molded Handle
- » Multiple Front Anchors for Clip-on Carabiners
- » Main Tool Compartment: 19 Pockets / Holds Drill / Drill Bit Organizer
- » Front Tool Compartment: 7 Pockets / Holds up to 8" Screwdrivers
- » Rear Tech Compartment: 3 Pockets / Holds 17" Laptop / Tablet / Files
- » Breathable Straps, With Moisture-Wicking Lining on Back to Manage Perspiration
- » Small Front Pocket & Side Cargo Pockets
- » Cell Phone Holder Fits Most Smart Phones
- » Holds up to 50 lbs
- » Total Number of Pockets: 34

▼ DO-DES



* It is not recommended to use a backpack over 35 lbs. for safety reasons

KNEE PADS AT A GLANCE

NO ROCK®
GEL
HDP223186



Cap



Padding



Straps



Lining



Closure



GEL
HARD CAP
HD98000



Cap



Padding



Straps



Lining



Closure

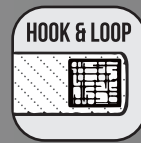

GEL
FLEXIBLE
HDP223155



Cap



Padding



Straps



Lining



Closure



GEL
ELIMINATOR
HD99000



Cap



Padding



Straps



Lining



Closure



GEL
ALL TERRAIN
HD95000



Cap



Padding



Straps



Lining



Closure



GEL KNEEPAD LAYERS

CAP *Hard or Soft*

FABRIC

WATERPROOF BACKING

FOAM

GEL *Recessed Insert*

NEOPRENE

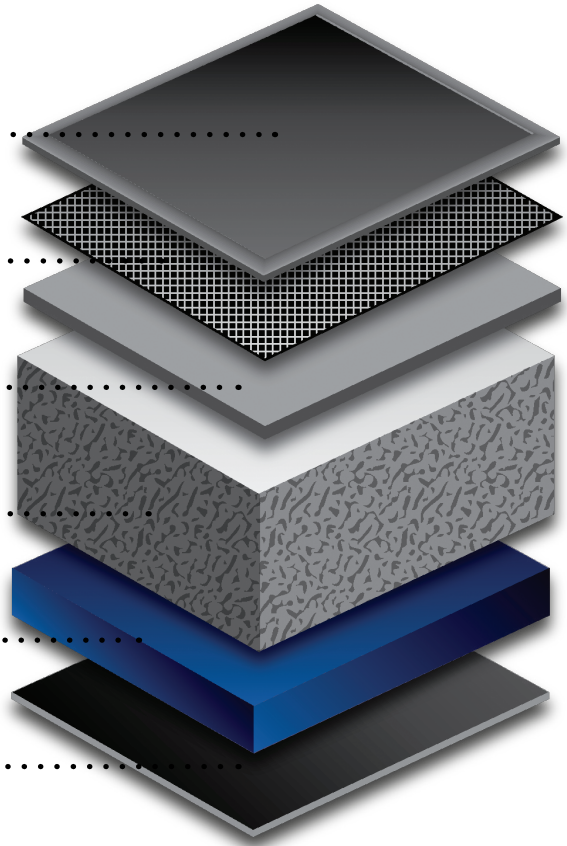

GelDOME®

NO ROCK® GEL

▼HDP223186



A premium, gel-padded knee pad, with primary uses for swiveling or sliding on: carpet, wood, sub floor, concrete and for general construction.

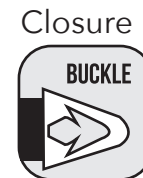
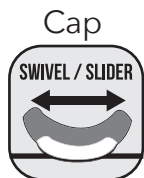

GeIDOME®

GEL HARD CAP ▼HD98000



A gel-padded kneepad, with primary uses for swiveling or sliding on: carpet, wood, sub floor, concrete and for general construction.

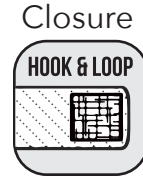

GeIDOME®

GEL FLEXIBLE ▼HDP223155



A premium, gel-padded "accordion-style" kneepad, with primary uses for: concrete, roofing, non-marring and non-slip applications.

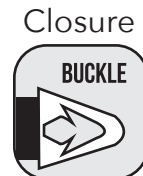

GeLDOME®

GEL ELIMINATOR

▼HD99000



A premium, gel-padded, non-marring kneepad, with primary uses for: flooring installation and working on tile / hardwood floors.

Cap



Padding



Straps



Lining



Closure

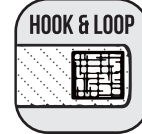

GeLDOME®

GEL ALL TERRAIN

▼HD95000



A gel-padded multi-purpose kneepad for general protection, featuring 4 raised corners to suspend the kneecap and reduce pressure.

Cap



Padding



Straps



Lining



Closure

